

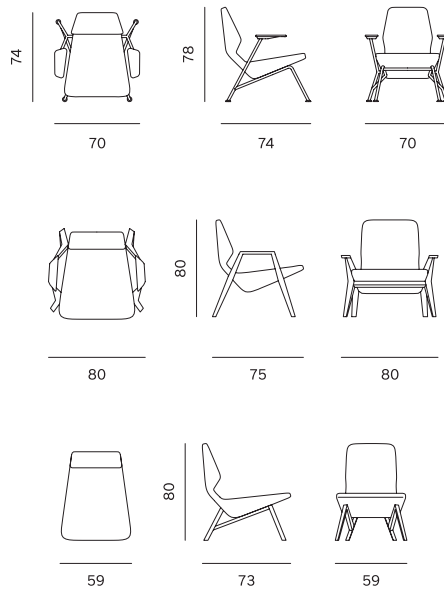

DESIGN: NUMEN / FOR USE

The basis of the system is the characteristic profile of a sofa which, defined by two triangular prisms, ensures maximum foam thickness on the rear of the seat and the backseat's lumbar area. The structural veneer moulding is bent around two axes and is upholstered together with the foam, resulting in a unified pulsating form. As a result of the triangulation, the solid oak legs thin towards the bottom, thus transforming the square cross-section of the top of the legs into their bases' triangle. The Oblique armchair with metal construction of the legs emphasizes the specific profile and volume of the armchair, thus losing the impression of massiveness that the armchair has in the wooden version. Oblique armchair with metal construction of the legs emphasizes the specific profile and volume of the chair, thus losing the impression of massiveness that the armchair has in the wooden version.

SEAT / SUPPORT	moulded foam, metal frame
UPHOLSTERY	fabric
LEGS	solid wood
FINISH	high quality oil / acrylic lacquer



CHAIR / STOLICA

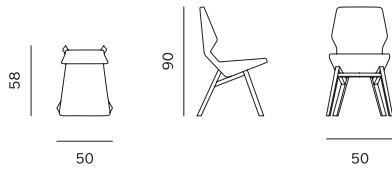

CHAIR METAL / STOLICA METALNA

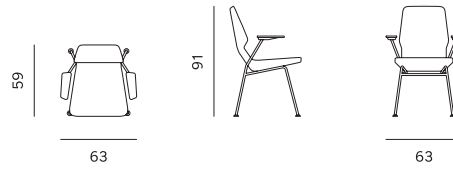

LOUNGE CHAIR / FOTELJA

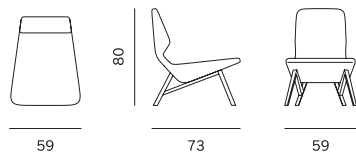

ARMCHAIR METAL / FOTELJA METALNA

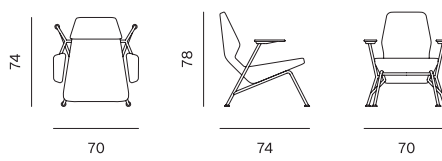

ARMCHAIR / FOTELJA S RUKONASLONIMA

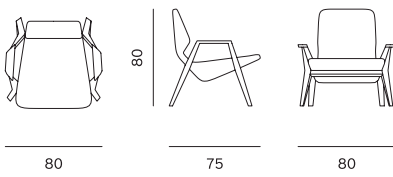

SMALL TABLES / STOLIĆI

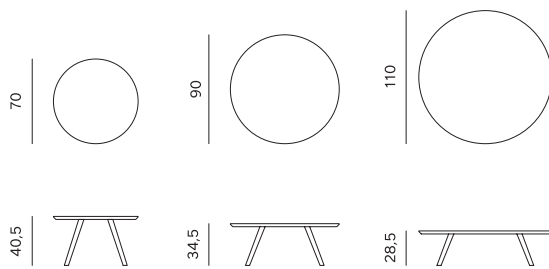

DINING TABLE / STOL

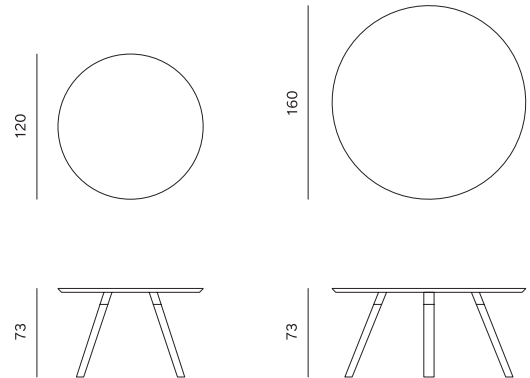

DINING TABLE / STOL

