

DOCKLANDS

The Dock-In Bays are screened bays for noisy offices and are the central element of DOCKLANDS range. An anchor point in a mobile working environment or private area dedicated to focused work in open space. Within a shared office environment the Dock-In Bay is a temporary, alternative workplace for individual focused work. Its inviting design and acoustic and visual screening provide a high level of comfort

at work. Dock-In Bays offer a wide range of uses for space planning and shaping without affecting a building's structure. Dock-In Bays are available in single or two-person work place units and allow for a variety of configurations: face to face, side by side, back to back, or in an unlimited row configuration, one after another.

Design: PearsonLloyd



PRODUCT DESCRIPTION

DOCK-IN BAYS

- 1 **Soft Wall:** comprising of several Soft Wall panels. A Wooden substructure upholstered with 5mm polyurethane foam padding on the inside and out. Foam in flame-resistant version according to BS 5852 Part 2, Ignition Source 5 (Crib 5). Interior and exterior coverings can be selected from a wide range of fabric groups. Covers always come with double stitching on all stitched edges.

Assembly of the Soft Wall panels is achieved by threading them together with 20mm thick rods, attached to a floor rail (SZ Black). Adjustable feet can be used to level the bays (± 5 mm).

Sound absorption according to ISO 11654 rated sound absorption level α_w 0.65 (in acoustically activated areas) Absorption class = C

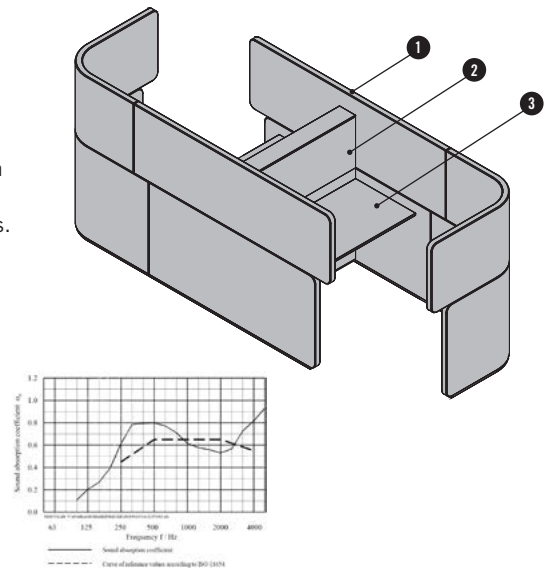

- 2 **Straight wall element:** comprising of a wooden (chipboard) frame with a melamine or veneer covered lower panel and a fabric upper panel. The lower panel can be optionally equipped with a flush-integrated connection plug board. Top and side cover plates, in Vanished MDF, conceal the inner frame. A peripheral black plastic base features adjustable feet to level the bays (± 5 mm).
- 3 **Table top:** 19mm chipboard or 13mm compact top in melamine or veneer. Table top connection using angle brackets can be levelled using slotted holes. Steel frame construction beneath the table top.

DOCK-IN LOUNGE

- 1 **Soft Wall:** comprising of several Soft Wall panels. A Wooden substructure upholstered with 5mm polyurethane foam padding on the inside and out. Foam in flame-resistant version according to BS 5852 Part 2, Ignition Source 5 (Crib 5).

Interior and exterior coverings can be selected from a wide range of fabric groups. Covers always come with double stitching on all stitched edges. Assembly of the Soft Wall panels is achieved by threading them together with 20mm thick rods, attached to a floor rail (SZ Black). Adjustable feet can be used to level the bays (± 5 mm).

Sound absorption according to ISO 11654 rated sound absorption level α_w 0.65 (in acoustically activated areas) Absorption class = C

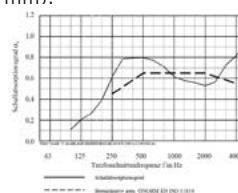

- 2 **Sofa:** The substructure of the back panel is made of plywood. Dimension cushions for backrest: 600x360mm. Frame: Powder-coated steel, dark grey with plastic glides

Dimensions: width 1.400 mm, height 459 mm, depth 720 mm, seat depth 495 mm

Covers are available in the fabric groups P0 - P4 & leather groups L1 - L2 in accordance with the Bene seating furniture collection.

Colour configuration options: single-coloured, different colour for recessed elements or different colour for recessed elements and back panel.

All upholstered elements contain dimensionally stable polyurethane foam padding. Optionally in flame-resistant version according to BS 5852 Part 2, Ignition Source 5 (Crib 5).

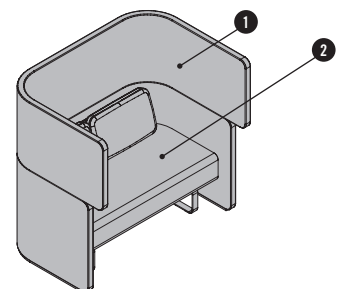

PRODUCT DESCRIPTION

SERVICE DOCK

- 1 **Soft Wall:** consisting of several panels. Wooden substructure, upholstered with 5 mm polyurethane foam padding on the inside and outside. Foam in flame-resistant version according to BS 5852 Part 2, Ignition Source 5 (Crib 5).

Interior and exterior covers can be selected from different fabric groups. Covers always come with double stitching on all stitched edges.

Assembly of the Soft Wall panels is achieved by threading them together with 20mm thick rods, attached to a floor rail (SZ Black). Adjustable feet can be used to level the bays (± 5 mm).

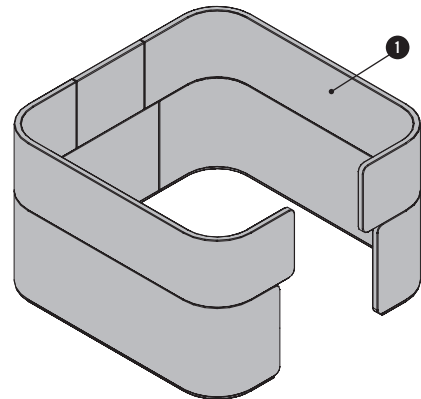

COAT RACK

- 1 **Soft Wall:** consisting of several panels. Wooden substructure, upholstered with 5 mm polyurethane foam padding on the inside and outside. Foam in flame-resistant version according to BS 5852 Part 2, Ignition Source 5 (Crib 5).

Interior and exterior surfaces can be selected from different fabric groups. Covers always come with double stitching on all stitched edges.

Connection of Soft Wall panels over 20 mm threaded rods in the floor rail, in SZ black, levelling with the help of adjustment feet ± 5 mm.

- 2 **Coat rod:** in chrome, diameter 28 mm

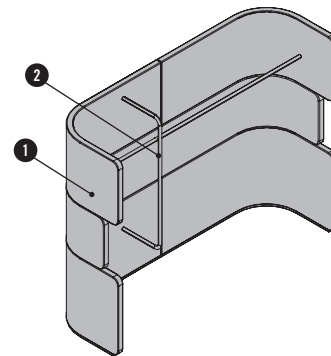

PHONE BOOTH

- 1 **Top ring**
- 2 **Middle ring**
- 3 **Bottom ring**

The Phone Booth consists of three shaped wood segments, upholstered with dimensionally stable polyurethane foam padding. In flame-resistant version according to BS 5852 Part 2, Ignition Source 5 (Crib 5). Covers always come with double stitching.

Supportive metal rod structure screwed to steel tubing base. Metal floor ring in SZ black, powder-coated.

The Phone Booth must be mounted to a wall or a building wall with the included wall-mounting bracket.

Sound absorption according to ISO 11654
Rated sound absorption level α_w 0.65
(in acoustically activated areas)
Absorption class = C

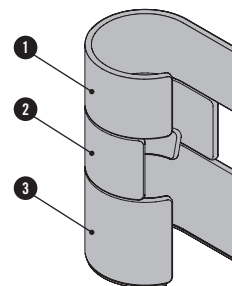
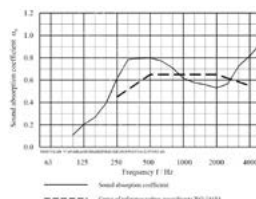

Configuration options:

- Single-coloured
- Inside and outside colours different
- Inside single-coloured, outside multi-coloured
- Outside colour of the ring is the same as the inside colour

OVERVIEW & DIMENSIONS

DOCK-IN BAY OPEN BAY

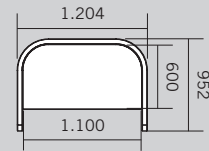
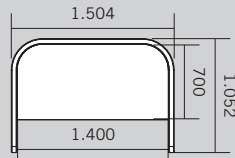
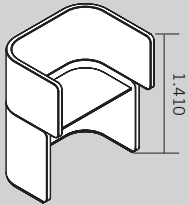

DOCK-IN BAY SINGLE BAY

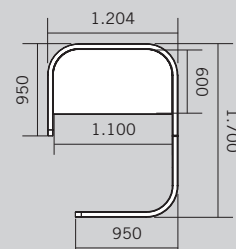
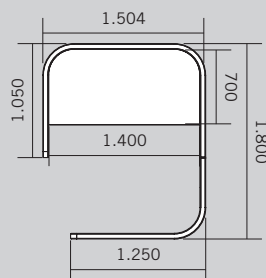
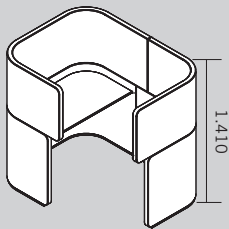

DOCK-IN BAY WALL BAY

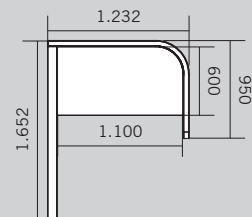
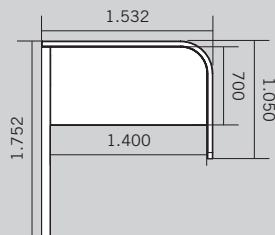
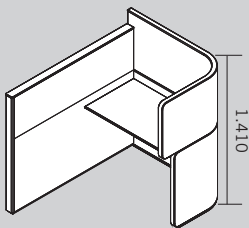

DOCK-IN BAY TWIN BAY

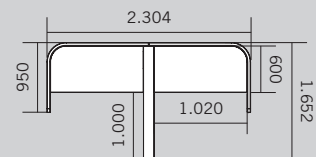
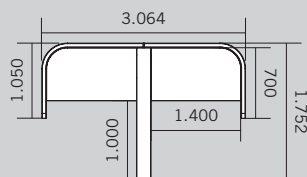
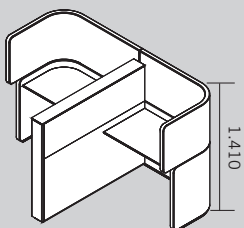

Measurements in mm

OVERVIEW & DIMENSIONS

DOCK-IN BAY DOUBLE BAY - ENTRANCE LEFT/RIGHT

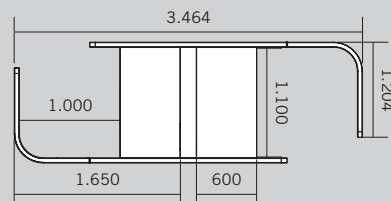
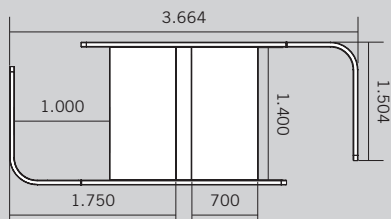
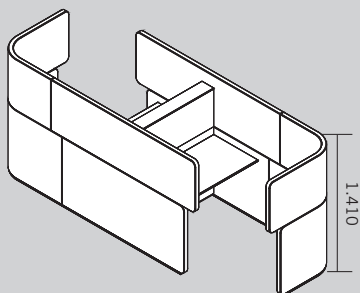

DOCK-IN BAY DOUBLE BAY - ONE-SIDED ENTRANCE

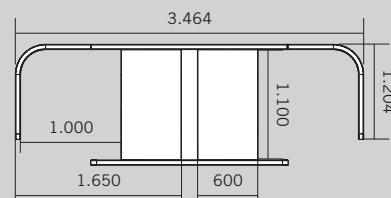
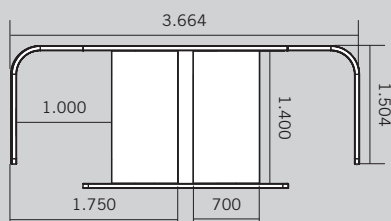
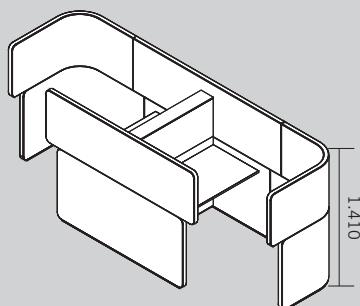

DOCK-IN LOUNGE OPEN LOUNGE

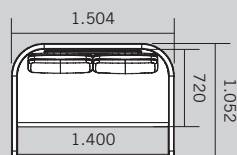
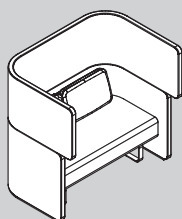

DOCK-IN LOUNGE SINGLE LOUNGE - ENTRANCE LEFT

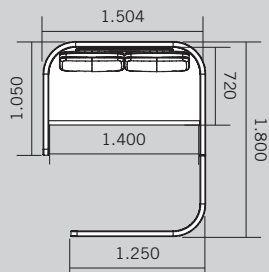
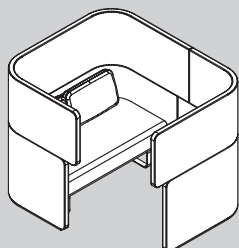

DOCK-IN LOUNGE SINGLE LOUNGE - ENTRANCE RIGHT

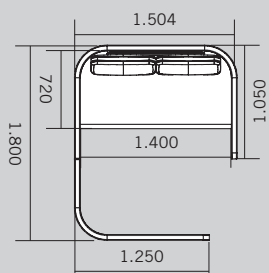
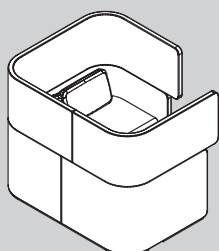

Measurements in mm

OVERVIEW & DIMENSIONS

SERVICE DOCK

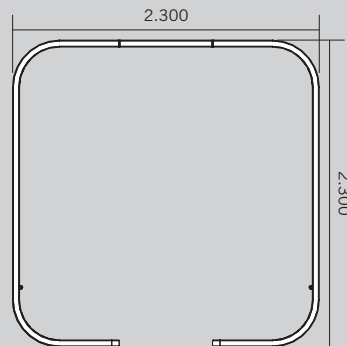
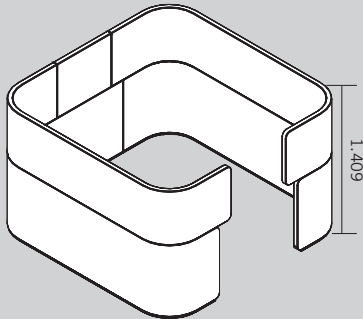

COAT RACK

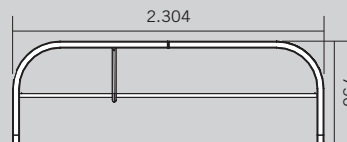
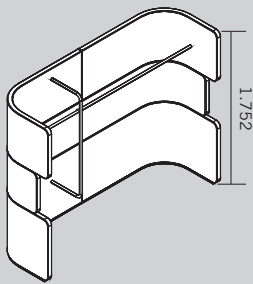

PHONE BOOTH

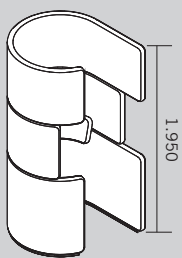

Measurements in mm

OPTIONS - DOCK-IN BAYS

CABLE TRAY

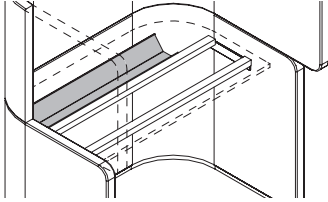

Foldable cable tray available in 2 widths, depending on table width.
Optional selection, always automatically included when integrating a plug box.

Material and colour: Steel plate, SZ black powder-coated.

TABLE TOP SLOT

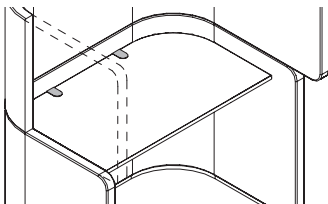

1 to 3 slots, depending on width of Dock-In Bay and installation of a plug box.
Quantity and positions are fixed and cannot be changed.

Material and colour: Plastic, AL aluminium or SZ black.

GROMMET HOLE

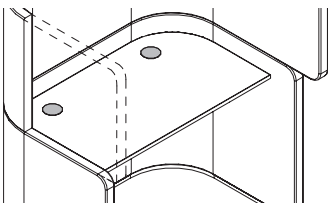

Maximum 2 grommet holes per table top. Diameter 80 mm. If a plug box is selected for another position, then a cable outlet can no longer be integrated in that position.

Positions: left, right, centre (excludes left and right) or * left and right

*If cable outlets are configured for left and right, a plug box can also be installed in the centre of a table top with a width of 1.400 mm.

Material and colour: Plastic, in WI white, AL aluminium or SZ black.

PLUG BOX

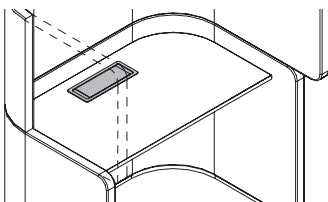

Maximum 1 plug box per table top. If a cable outlet is selected for another position, then a plug box can no longer be integrated in that position.

Positions: left, right or *centre

*If cable outlets are configured for left and right, a plug box can also be installed in the centre of a table top with a width of 1.400 mm.

Material and colour: AL anodised aluminium

SHORTENED TABLE TOP

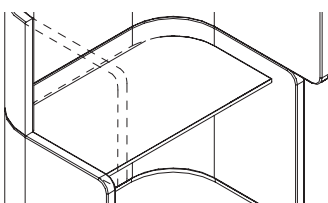

The table top's depth can be reduced so that cabling can be run in the rear over the 20 mm gap. In case of a shortened table top, a 3A connection plug board with aluminium enclosure cannot be mounted using a universal adapter.

OPTIONS - DOCK-IN BAYS

CABLING

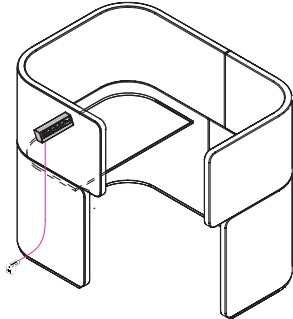

Dock-In Bays

Connection types

- Behind panel/ to universal adapter
- In top section/ to universal adapter
- With table clamp for 13 - 25 mm top thickness

- 1 connection plug board with 4x power sockets incl. switch
or 3x power sockets incl. sockets, 2x RJ45-CAT6
or 2x power sockets incl. switch, 2x RJ45-CAT6, 2x USB

- 1 electrical starter cable GST18 5.000 mm

CABLING IN THE WALL

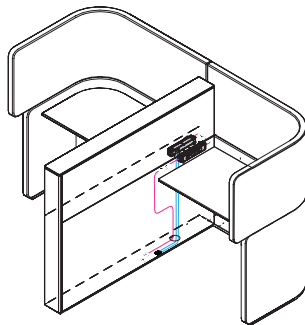

Twin Bay and Double Bay

- 2 connection plug boards with 4x power sockets
 - *or 3x power socket, 2x RJ45-CAT6
 - *or 2x power socket, 2x RJ45-CAT6, 1x VGA and audio
 - *or 2x power socket, 2x RJ45-CAT6, 1x HDMI and audio

- 1 electrical starter cable GST18 5.000 mm
- Optional: 1 electrical interconnecting cable GST 18 5.000 mm

- *Optional: 2 input cable sets (2x network cables RJ45-CAT6 1.200 mm)

Wall Bay

- 1 connection plug board with 4x power sockets
 - *or 3x power socket, 2x RJ45-CAT6
 - *or 2x power socket, 2x RJ45-CAT6, 1x VGA and audio
 - *or 2x power socket, 2x RJ45-CAT6, 1x HDMI and audio

- 1 electrical starter cable GST18 5.000 mm
- Optional: 1 electrical interconnecting cable GST 18 5.000 mm

- *Optional: 1 input cable set (1x network cables RJ45-CAT6 1.200 mm)

CABLING UNDER THE DESK (EXTENSION)

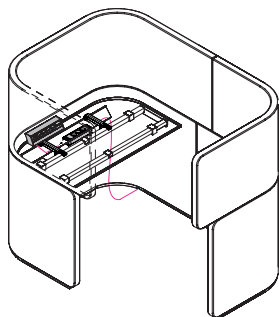

Open Bay, Single Bay and Wall Bay

- 1 connection plug board with 3x power sockets
- 1 electrical starter cable GST18 5.000 mm
- Optional: 1 electrical interconnecting cable GST 18 5.000 mm

Twin Bay and Double Bay

- 2 connection plug boards with 3x power sockets
- 1 electrical starter cable GST18 5.000 mm
- Optional: 1 electrical interconnecting cable GST 18 5.000 mm

OPTIONS - DOCK-IN BAYS

LAMP 180 ADAPTED

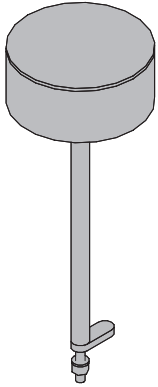

LED.next technology from Nimbus with diffuser surface made of acrylic glass for glare suppression and downward lighting with aligned conical holes. Luminaire head, tube and base in AL aluminium, powder-coated. Translucent lamp shade made of polyester film. Contact-free IR sensor switch with infinite dimming function in the foot of the luminaire.

Version screwed directly to the desktop.

Connected load: 8 W
 Luminous flux: 550 lm
 Colour temperature: 3.000 K
 Dimensions: 180 x 180 x 450 mm
 Weight: ca. 1.100 grams

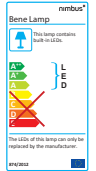

Possible positions for attaching the luminaires to the desk in the Dock-In Bays

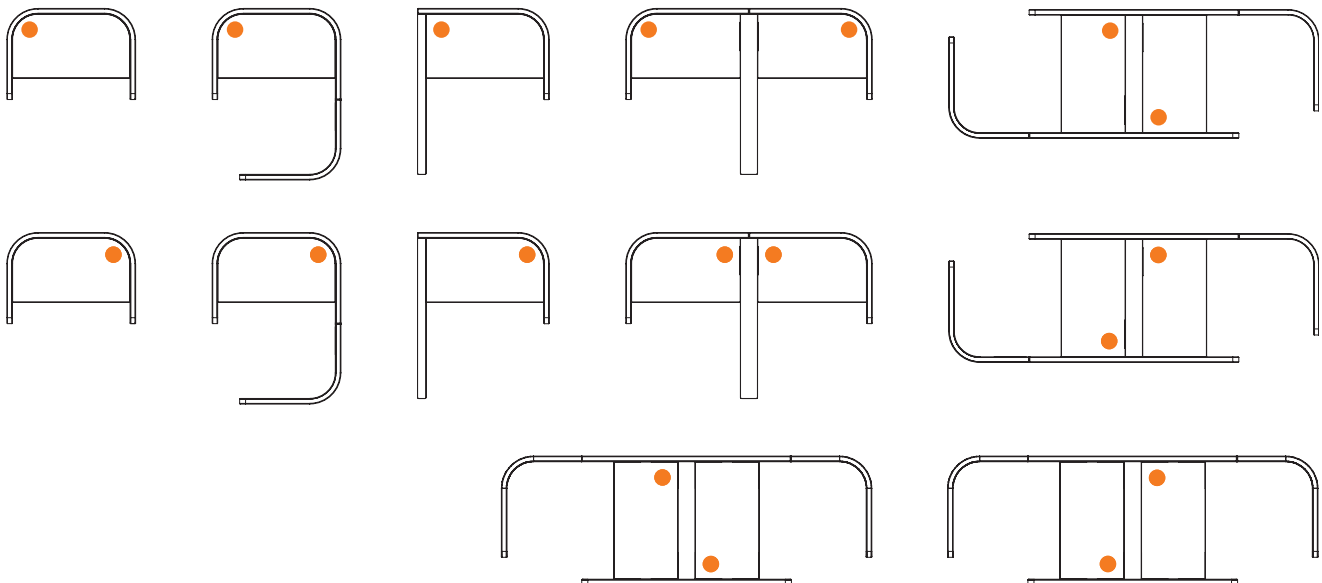

OPTIONS - DOCK-IN BAYS/DOCK-IN LOUNGE

DESK SHELF

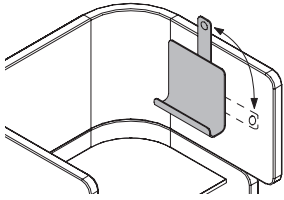

Maximum 1 desk shelf per temporary workplace. Equipped with a presence indicator that can be pointed upwards to show that the workplace is occupied.

Material and colour: Aluminium in WI white
The presence indicator has the same design as the desk shelf.

Position is fix and cannot be changed.

Possible positions

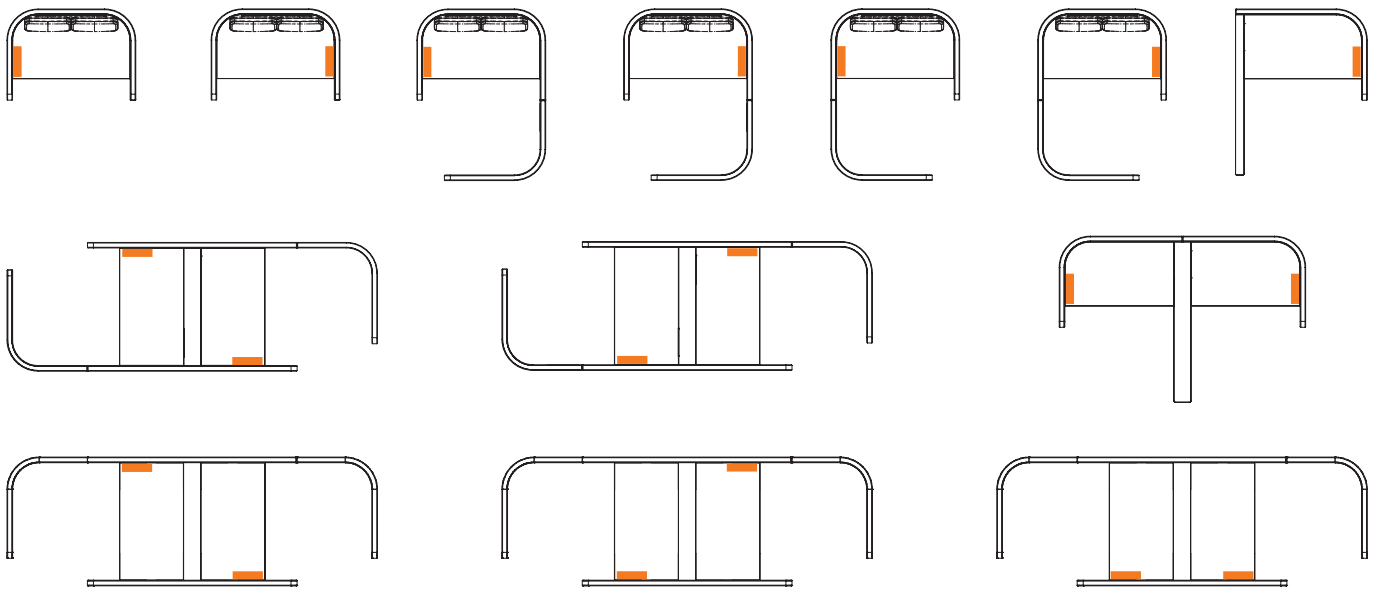

CLOTHES HANGER

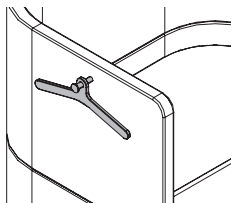

Maximum 1 clothes hanger per temporary workplace.
Material and colour: MDF varnished in WI white
Position is fix and cannot be changed. Maximum load: 10 kg

Possible positions

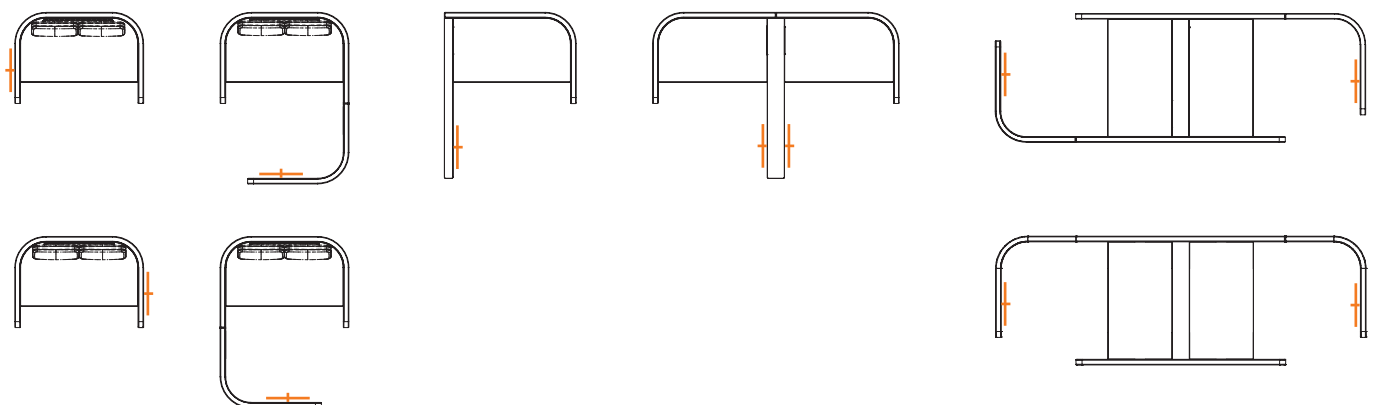

OPTIONS

ATTACHMENT TABLE - DOCK-IN LOUNGE

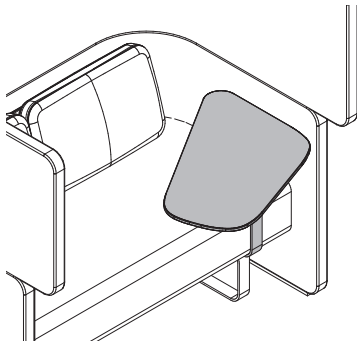

Optionally mountable left or right of Dock-In break-out area.
Table top: Compact top, melamine 13 mm. Steel brackets: dark grey, powder-coated.
Dimensions: Width 821 mm, depth 434 mm

Maximum load: 10 kg
Colours based on the Bene collection in melamine groups 1 and 2.

The version includes connection plug board OU „Phase“

- 1x power socket
- 2x USB charging port
- 2 m starter cable
- Electricity module available in A, D, F, L

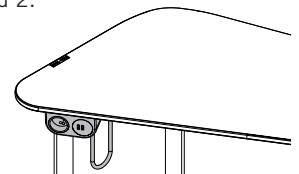

Optionally available without connection plug board.

CLOTHES HANGER - COAT RACK

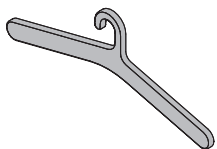

Material and colour: MDF varnished in WI white

PERCH - PHONE BOOTH

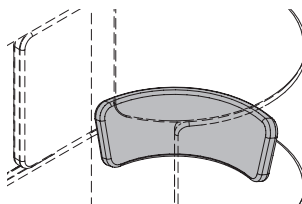

The perch is made of a shaped wood base plate, upholstered with dimensionally stable polyurethane foam padding. Can be hooked into the Phone Booth's support structure between the middle and bottom ring. Covers always come with double stitching. Covers are available in all fabrics in price groups P0 and P2-P4 from the Bene seating furniture collection.

SHELF - PHONE BOOTH

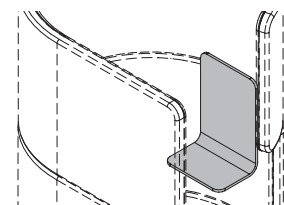

Desk shelf consisting of shaped wood with veneered or varnished surface.
It is hung between the middle and upper rings.

Colours: Varnished MDF (WI white, BS basalt), veneer group 1 oak (EY oak sylt)
Dimensions: Width: 270 mm, Depth: 190 mm, Height: 385 mm

INSPIRATIONS



DOCKLANDS Single Bay including shelf and clothes hanger with Bay Chair.



DOCKLANDS Double Bay entry left incl. shelf and clothes hanger with Bay Chair.

COLOURS & MATERIALS

MELAMINE: Basic colours

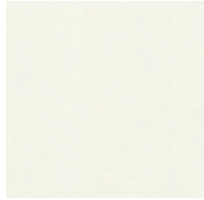

MW white

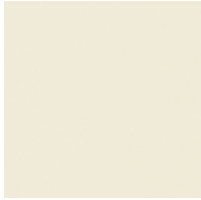

MQ office white

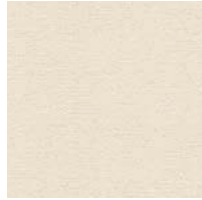

MC canvas



MP platinum



TM clay

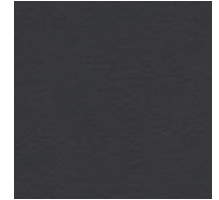

MT anthracite



MA aluminium

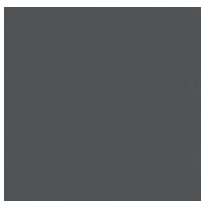

MS slate

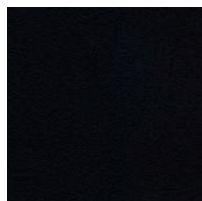

MB basalt

MELAMINE: Additional basic colours

MELAMINE: Décor colours

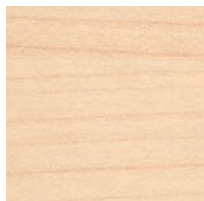

AR maple

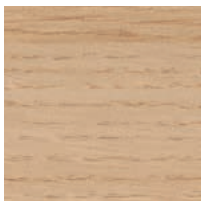

EI oak

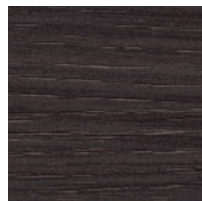

EC oak moreda

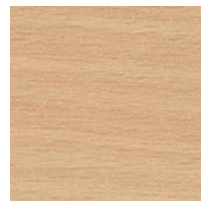

BH beech, light

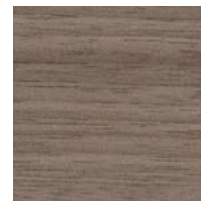

NG walnut grey

MELAMINE: Décor colours with texture



CE elm, white



CO coco

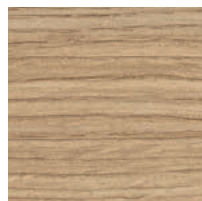

EA oak aragon

MELAMINE: Accent colours



TX mustard



TH marino blue



TS fern green

COLOURS & MATERIALS

VENEER: Maple

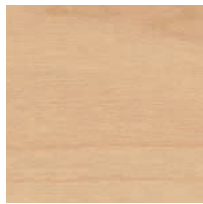

AK canad. maple

VENEER: Beech



BG beech grey

VENEER: Oak

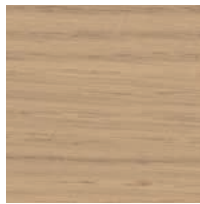

EY oak sylt

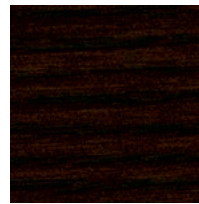

ER oak amaretto

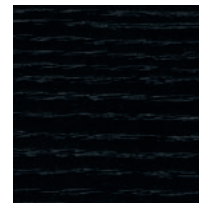

EV oak volcano



EG oak grey

VENEER: Chestnut

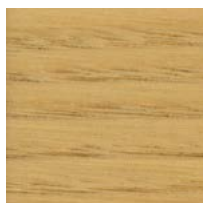

KD chestnut natural



KP chestnut brown



KQ chestnut grey

VENEER: Walnut

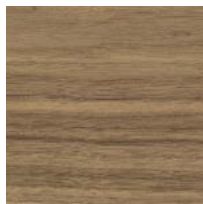

NF american walnut

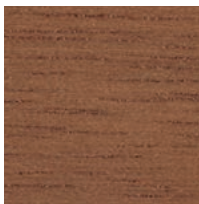

NR walnut siena

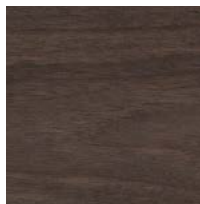

NB walnut umbra

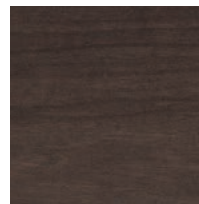

NA wal. anthracite

VENEER: Bamboo

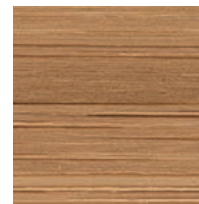

BJ bamboo



All fabric and leather collections are available as cover: Urban Plus, Xtreme Plus, Step, Step Melange, Patina, Remix, Europost, Clara, Mainline Flax, Fiord, Divina, Steelcut, Hallingdal, Steelcut Trio, Divina Melange, Divina MD, Greenwich, Greenwich Uni. More information about the specific fabric collections is available at www.bene.com.

BENE WORKS SUSTAINABLY

Bene plays a leading role in responsible environmental management. This policy is practised throughout all company divisions – from product development, procurement, production and logistics to product recycling. Bene considers ecology to be a central element of its responsible and sustainable corporate strategy. Bene sees the legal regulations as minimum requirements and strives for better and more sustainable environmental protection throughout the group. Bene's environmental policy principle is: **Avoidance – Minimisation – Recycling – Disposal.**

DOCKLANDS SINGLE BAY – ECOLOGICAL STANDARDS

- 99% recyclable
- 83.50% renewable raw materials
- 12.97% use of recycled product materials (9.10% post-consumer, 3.87% pre-consumer)
- 10.61% use of recycled product materials that comply with LEED (9.10% post-consumer, 3.87% pre-consumer)
- Resource-conserving product design
- Use of certified wood (chain of custody)
- Use of materials tested for presence of hazardous substances
- No PVCs, chromium, lead or mercury
- Individual parts can be sorted according to homogeneous categories
- Recyclable, with a positive contribution to the carbon footprint(average 160.5 kg CO₂)

DOCKLANDS SINGLE BAY LEED POINTS

Leadership in Energy and Environmental Design (LEED) is a system developed by the U.S. Green Building Council to classify ecological construction. As an internationally recognised standard, LEED sets out numerous guidelines for environmentally friendly, resource-efficient, and sustainable construction. The use of DOCKLANDS Single Bay is an important contribution to LEED certification. The following criteria for this are from »LEED 2009 for Commercial Interiors«:

MR Credit 4 Recycled content up to 2 points

MR Credit 5 Regional materials up to 2 points

MR Credit 7 Certified wood up to 1 point

IEQ Credit 4.5 Material with low hazardous substance content up to 1 point

DOCKLANDS SINGLE BAY MATERIAL COMPONENTS

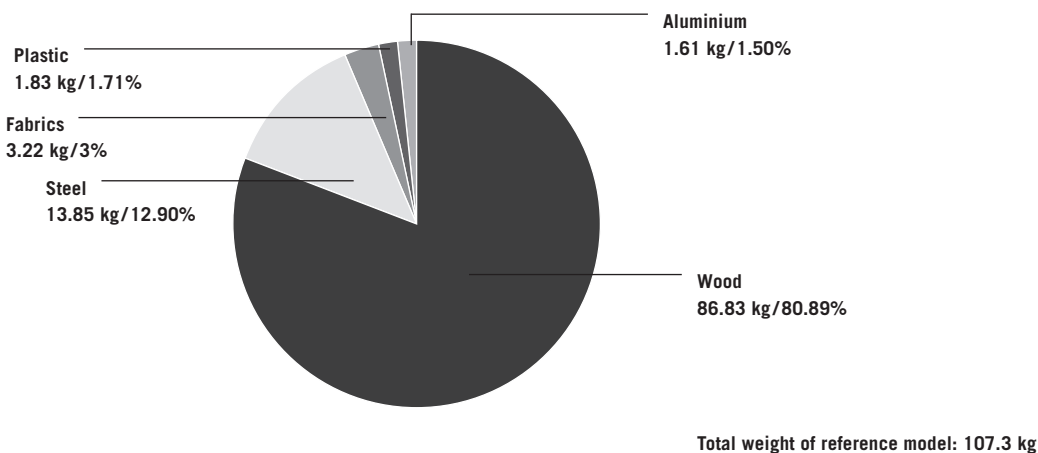

Environment-related information about Bene: www.bene.com/sustainability

