

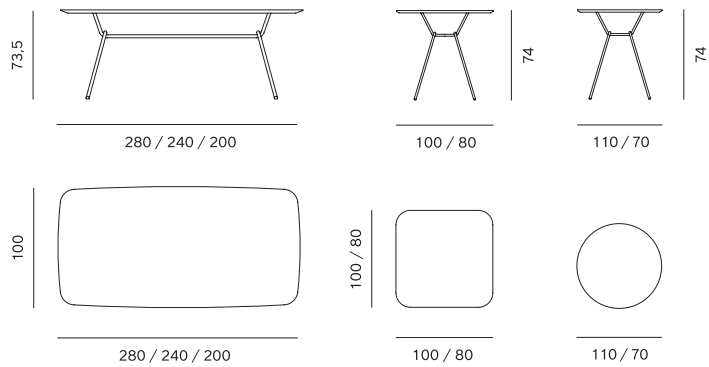

DESIGN: SIMON MORASI PIPERČIĆ

Newest addition to the collection is a line of tables with typical Strain base. Interweaving steel tubes make an elegant base to a thin looking table top made with Fenix NTM finishing, either in MDF with lacquered edges or in plywood with visible edge. The table comes in various sizes and can fit different types of chairs.

PANEL	MDF
TABLE TOP	Fenix NTM
BASE	metal
BASE FINISH	powder coated matte



LOUNGE CHAIR / FOTELJA

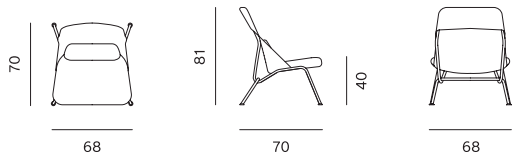

SMALL TABLE / STOLIĆ

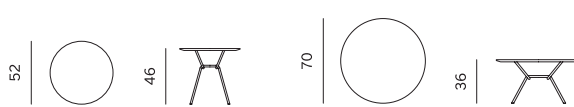

BAR STOOL HIGH / BARSKI STOLAC VISOKI

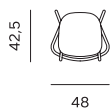

BAR STOOL LOW / BARSKI STOLAC NISKI

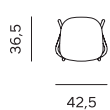

STOOL / STOLAC

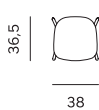

TABLE / STOL

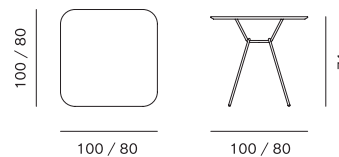
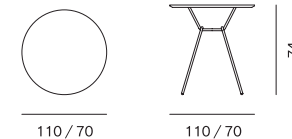

TABLE / STOL

